



POSSUM KINGDOM TACTICAL

◦ ENHANCED RIFLES ◦

PELZER, SC

Safety & Instruction Manual

For: PKT-BAP & BBP "Baby Possum," PKT-LP "Little Possum," PKT-BIP & BGP "Big Possum" and PKT-FM "Nocturne" AR rifles, carbines and pistols



Read the instructions and warnings in this manual CAREFULLY BEFORE using this firearm.

132 Stoddard Road • Pelzer, SC 29669

864-360-05147

<https://pkt.fyi>

Copyright © 2026 Possum Kingdom Tactical LLC
All rights reserved.



WARNING:



READ THESE INSTRUCTIONS AND WARNINGS CAREFULLY. BE SURE YOU UNDERSTAND THESE INSTRUCTIONS AND WARNINGS BEFORE USING THIS FIREARM. FAILURE TO READ THESE INSTRUCTIONS AND TO FOLLOW THESE WARNINGS MAY RESULT IN SERIOUS INJURY OR DEATH TO YOU AND OTHERS AND DAMAGE TO PROPERTY.

THIS SAFETY & INSTRUCTION MANUAL SHOULD ALWAYS ACCOMPANY THIS FIREARM AND BE TRANSFERRED WITH IT UPON CHANGE OF OWNERSHIP OR WHEN PRESENTED TO ANOTHER PERSON. A COPY OF THE SAFETY & INSTRUCTION MANUAL IS AVAILABLE FREE VIA

**DOWNLOAD AT: [HTTPS://PKT.FYI](https://pkt.fyi)
OR UPON REQUEST FROM PKT
CUSTOMER SUPPORT CENTER
864-921-0472 or 864-360-05147
email:**

support@pkt.fyi

NOTE: PKT pistols are designed to be held and fired using a single hand. Some PKT pistols are shipped from the factory equipped with a stabilizing arm brace to facilitate one-handed firing. The stabilizing arm brace is designed to be used by loosening the adjustable nylon strap and inserting the forearm through the brace, taking hold of the firearm grip with the firing hand and then adjusting the nylon strap around the user's forearm for a comfortable fit. The arm may then be extended to fire the firearm in the normal manner. Alterations to PKT pistols, such as replacement of the stabilizing arm brace with a butt-stock, removing the arm-strap, or installation of a vertical foregrip, will subject the firearm to regulation under the National Firearms Act (NFA), as well as state and local laws. It is the duty of the PKT firearm user to understand and comply with all applicable Federal, state and local laws. Consult the Bureau of Alcohol, Tobacco, Firearms, and Explosives (website: www.atf.gov) or your local law enforcement agency for more information. Contact the ATF for any updates concerning ATF rule changes.

TABLE OF CONTENTS

YOUR SAFETY RESPONSIBILITIES	3-6
SAFE STORAGE AND TRANSPORTATION	7-8
AMMUNITION	9-11
MODEL AND FEATURES IDENTIFICATION	12
INSPECTING YOUR FIREARM	13-14
PREPARATION FOR FIRING	15
LOADING	16-19
FIRING.....	19
HANGFIRES AND MISFIRES	20-21
CLEARING A MISFEED / JAM	22
UNLOADING	22
DISASSEMBLY / FIELD STRIPPING	22-26
SPECIAL COMPONENT DISASSEMBLY	26-28
ASSEMBLY	29
STABILIZING ARM BRACE	29
INSTALLATION OF OPTICS	30
MAGAZINE	31
CLEANING AND MAINTENANCE	32-34
LIMITED WARRANTY	35-36
CONTACT AND SHIPPING INFORMATION	37-38
CUSTOM SERVICE AND PATENT INFORMATION	39
ADDENDUM: M-LOK® ACCESSORY RAILS	40-45
BATTERY WARNINGS	46

YOUR SAFETY RESPONSIBILITIES

SAFETY IS YOUR NUMBER ONE RESPONSIBILITY!

- At home, in the field, at the range, or anywhere, the first concern of every firearm owner should be safety. Apply the following safety rules in every situation, with any kind of firearm. If you feel uncertain about any operational aspects of your firearm, please contact PKT at 864-360-5147, before proceeding with its operation.
- If you are unfamiliar with firearms you should seek formal training before using your firearm.



WARNING: YOU MUST FOLLOW ALL OF THESE SAFETY RULES TO ENSURE THE SAFE USE OF YOUR FIREARM. THE FAILURE TO FOLLOW THE INSTRUCTIONS AND WARNINGS IN THIS MANUAL COULD CAUSE SERIOUS PERSONAL INJURY OR DEATH TO YOU OR OTHERS AND DAMAGE TO PROPERTY.

- As a firearm owner, you accept a demanding responsibility. How seriously you take this responsibility can be the difference between life and death. There is no excuse for careless or abusive handling of your firearm. At all times handle your firearm with intense respect for its power and potential danger.

YOUR SAFETY RESPONSIBILITIES CONTINUED

- **ALWAYS KEEP YOUR FIREARM POINTED IN A SAFE DIRECTION.** Never point a firearm at anyone or anything you do not intend to shoot, whether or not it is loaded. This is particularly important when loading, unloading, or field stripping the firearm. ALWAYS control the direction of the firearm.
- **ALWAYS TREAT EVERY FIREARM AS IF IT IS LOADED AND WILL FIRE.** Do not take anyone's word that the firearm is unloaded – always check for yourself. Never pass your firearm to another person until the action is open and you visually check that it is unloaded. Keep your firearm unloaded and safely stored when not in use.
- **NEVER PLACE YOUR FINGER INSIDE THE TRIGGER GUARD OR ON THE TRIGGER UNLESS YOU INTEND TO FIRE.** Ensure that other objects do not touch the trigger.
- **ALWAYS BE SURE OF YOUR TARGET AND WHAT IS BEYOND IT.** Always be sure of where the bullet will strike and shoot only where there is a safe back stop free of obstructions, water or other surfaces which can cause a ricochet. Be sure your bullet will stop behind your target. Bullets can glance off many surfaces like rocks or the surface of water and travel in unpredictable directions with considerable velocity. Do not fire randomly into the sky.
- **NEVER CROSS OBSTACLES SUCH AS FENCES OR STREAMS WITH A LOADED FIREARM.** Always make certain your firearm is unloaded before crossing a fence, climbing a tree, jumping a ditch or negotiating other obstacles.
- **SAFE FIREARM HANDLING IS YOUR PERSONAL RESPONSIBILITY AT ALL TIMES.** Firearms are dangerous and can cause serious injury or death if they are misused or used inappropriately. Safety must be the prime consideration of any one who owns or handles firearms. Accidents are the result of violating the rules of safe firearm handling and common sense. Firearm safety training is available. Contact your firearms dealer, law enforcement agency, local sportsman's club, etc. for availability.
- **YOU ARE RESPONSIBLE FOR THE FIREARM AT ALL TIMES.** In owning a firearm, you must undertake full-time responsibility for your firearm's safety and security. You must protect yourself and all others against injury or death from misuse of the firearm, 24 hours a day.
- **FIREARM SECURITY IS YOUR RESPONSIBILITY.** You must secure firearms safely from children and/or unauthorized users. Your firearm should always be kept unloaded and locked when not in use. A lock has been provided for this purpose. Never assume that the use of this lock is sufficient to safely secure your firearm. You must always evaluate your personal situation and employ the security systems that meet your needs and prevent children and unauthorized users from gaining access to your firearm.

YOUR SAFETY RESPONSIBILITIES CONTINUED

- **APPROPRIATE USE FOR YOUR FIREARM MEANS USING YOUR FIREARM FOR LEGAL PURPOSES.** For example -target shooting, hunting and lawful resistance of deadly criminal force. It is your responsibility to ensure that you are in compliance with all applicable laws and ordinances regarding the use of your firearm.
- **NEVER RELY ON MECHANICAL FEATURES ALONE.** Only your safe firearm-handling habits will ensure the safe use of your firearm. This is your responsibility.
- **ALWAYS SAFELY STORE AND SECURE YOUR FIREARM.** Safe and secure storage of your firearm is one of your most important responsibilities. It is a full-time responsibility. You must always secure your firearm and ammunition separately so that they are not accessible to children and/or other unauthorized persons.
- **NEVER KEEP AMMUNITION IN THE SAME LOCATION AS THE FIREARM.** Store each in a separate and secure place.
- **ALWAYS WEAR EYE PROTECTION THAT IS SPECIFIED FOR USE WITH FIREARMS** every time you handle your firearm for cleaning and maintenance.
- **ALWAYS WEAR EYE AND HEARING PROTECTION THAT ARE SPECIFIED FOR USE WITH FIREARMS** every time you discharge your firearm. Make sure others in the vicinity of where you will be shooting do so as well.
- **NEVER USE ALCOHOL OR DRUGS BEFORE OR WHILE SHOOTING.** Do not use your firearm if you are on any medication which impairs, even slightly, your mental or physical ability.
- **ALWAYS HAVE ADEQUATE VENTILATION.** Discharging firearms in poorly ventilated areas, cleaning firearms, or handling ammunition may result in exposure to lead and other substances known to cause birth defects, reproductive harm, and other serious physical injury. Review the warnings and labels for all ammunition and cleaning products carefully. Wash hands thoroughly after exposure.
- **BEFORE HANDLING ANY FIREARM, UNDERSTAND ITS OPERATION.** Not all firearms are the same. Familiarize yourself with the mechanical features of any firearm you intend to use. If you feel uncertain about any operational aspects of your firearm, please contact PKT at 864-921-0472 or 864-360-5147 before proceeding with its operation.
- **NEVER ALLOW A FIREARM TO BE USED BY INDIVIDUALS WHO DO NOT UNDERSTAND ITS SAFE OPERATION OR HAVE NOT READ THESE FIREARM SAFETY RULES.**

YOUR SAFETY RESPONSIBILITIES CONTINUED

- **ALWAYS USE THE CORRECT AMMUNITION FOR YOUR PARTICULAR FIREARM** as indicated by the marking on the firearm. Never use non-standard, reloaded, or “handloaded” ammunition which has not been subjected to internal ballistic pressure testing.
- **BEWARE OF BARREL OBSTRUCTIONS** Be sure the barrel is clear of obstructions before shooting. Mud, water, snow or other objects may inadvertently lodge in the barrel bore. A small obstruction can cause a dangerous increase in pressure and may damage your firearm and cause injury to yourself and others.
- **BE SURE ALL ACCESSORIES, SUCH AS HOLSTERS, GRIPS, SLINGS, SCOPES AND OTHER ACCESSORIES ARE COMPATIBLE** with the firearm and that the accessories do not interfere with safe operation. It is your responsibility to understand and follow all of the instructions in this manual, as well as those which may be supplied with your ammunition and any accessory.
- **NEVER DISASSEMBLE YOUR FIREARM** beyond the field stripping procedure outlined in this manual. Improper disassembly or reassembly of your firearm may be dangerous and can lead to serious injury or death.
- **NEVER MANIPULATE, ADJUST OR CHANGE ANY OF THE INTERNAL COMPONENTS OF YOUR FIREARM UNLESS SPECIFICALLY INSTRUCTED TO DO SO IN THIS MANUAL.** Improper manipulation of any other internal component may affect the safety and reliability of your firearm and may cause serious injury or death.
- **NEVER ALLOW ANY ALTERATION OR REPLACEMENT OF PARTS IN YOUR PKT FIREARM UNLESS PERFORMED BY A QUALIFIED GUNSMITH** using genuine PKT parts. If you do otherwise, improper functioning of your firearm may occur and serious injury or death and damage to property may result.



WARNING: SAFE USE OF A FIREARM IS YOUR PERSONAL RESPONSIBILITY AND THE FAILURE TO FOLLOW ALL OF THESE BASIC SAFETY RULES MAY RESULT IN SEVERE PERSONAL INJURY OR DEATH TO YOU OR OTHERS AND DAMAGE TO PROPERTY. YOU ARE THE MOST IMPORTANT SAFETY DEVICE WHEN IT COMES TO THE USE OF YOUR FIREARM AND POSSUM KINGDOM TACTICAL LLC WILL NOT BE RESPONSIBLE FOR ANY PERSONAL INJURY, DEATH OR PROPERTY DAMAGE THAT RESULTS FROM: (1) THE CRIMINAL OR NEGLIGENT USE OF THIS FIREARM; (2) A DISREGARD OF THESE SAFETY INSTRUCTIONS AND WARNINGS; (3) IMPROPER OR CARELESS HANDLING OF THIS FIREARM; (4) THE USE OF NON-STANDARD, DEFECTIVE, OR IMPROPER AMMUNITION; (5) OR, IMPROPER OR NEGLIGENT MODIFICATIONS OR REPAIRS TO THE FIREARM.

SAFE STORAGE AND TRANSPORTATION



WARNING: ALWAYS POINT THE MUZZLE IN A SAFE DIRECTION.



WARNING: FIREARMS ARE DANGEROUS WHEN USED AND STORED IMPROPERLY. THEY POSE A RISK OF SERIOUS OR FATAL INJURIES. FIREARMS CAN BE ESPECIALLY DANGEROUS TO CHILDREN WHEN THEY ARE STORED IN AN IRRESPONSIBLE AND UNSAFE MANNER. FOR YOUR SAFETY AND THE SAFETY OF OTHERS, IT IS IMPERATIVE THAT YOU KEEP YOUR FIREARM LOCKED AND UNLOADED IN A SECURE PLACE. THE AMMUNITION SHOULD BE STORED IN A SEPARATE, SECURE LOCATION WHEN IT IS NOT IN USE. SAFE AND SECURE STORAGE OF YOUR FIREARM IS ONE OF THE MOST IMPORTANT RULES OF FIREARM SAFETY. YOUR FAILURE TO FOLLOW THESE RULES MAY RESULT IN SERIOUS INJURY OR DEATH TO YOU OR OTHERS.

• **ALWAYS SECURE YOUR FIREARM IN A MANNER THAT WILL PREVENT UNAUTHORIZED ACCESS.** Whenever your firearm is not in use, keep it unloaded and locked. Your safety and the safety of others requires that you always secure and store your firearm in a manner that will prevent unauthorized access. Never leave a firearm unattended unless it is locked, unloaded and secured.

• **ALWAYS USE THE LOCK PROVIDED BY PKT TO SECURE YOUR FIREARM.** Please read and follow the instructions packaged separately for the use of this lock. A lock, when properly used, can be an effective tool in preventing unauthorized access to your firearm. There are other alternative locks and safe storage containers available in the marketplace which may also be appropriate for your particular needs. Consult your local firearm shop, hardware store, or local police department for guidance on the variety of other safe storage devices or practices which may be appropriate for your particular needs. By purchasing this firearm you have accepted the responsibility of safely securing the firearm at all times and preventing its unauthorized use. Never assume that the use of this lock alone is sufficient to safely secure your firearm. It is your personal responsibility to select and use whatever measures or practices that will enable you to be absolutely certain that your firearm is secure at all times.



WARNING: NEVER LOCK A LOADED FIREARM. NEVER LOAD A LOCKED FIREARM.

SAFE STORAGE AND TRANSPORTATION CONT'D

- **ALWAYS STORE YOUR FIREARM AND AMMUNITION SEPARATELY** so that they are not accessible to children or other unauthorized persons. Safe and secure storage of your firearm and ammunition are your responsibility. It is a full-time responsibility.
- **NEVER ASSUME THAT A "HIDING" PLACE IS A SECURE STORAGE METHOD.** Others may be aware of your storage location or come upon it by chance. It is your personal responsibility to use common sense when storing your firearm and ammunition and to always make sure they are not accessible to children or other unauthorized persons.
- **NEVER TRANSPORT A LOADED FIREARM.** When transporting your firearm, be sure it is unloaded and locked. Safe and secure transportation of your firearm is your responsibility.
- **ALWAYS FOLLOW THE LAW!** Many jurisdictions have laws that make it a crime to keep a firearm unlocked and in an area accessible to children or others. Keeping a firearm locked and unloaded when not in use is not only common sense safety practice... IT IS THE LAW. You must be familiar with all local, state, and federal laws regarding the safe storage and transportation of your firearm. Failure to know and follow the law may result in unauthorized access or use of your firearm by another. Obey all laws relating to the storage and transportation of firearms. Your local police department or firearm shop can furnish you with available information on storing and/or transporting a firearm safely and legally.
- **YOUR FIREARM IS YOUR RESPONSIBILITY.** You must prevent your firearm from being stolen or from being used by untrained or unqualified individuals. Keep it locked, unloaded and secured when not in use.
- Never leave the key with the stored firearm.

AMMUNITION



WARNING: NEVER USE AMMUNITION NOT SPECIFICALLY DESIGNATED FOR USE IN YOUR FIREARM. FAILURE TO USE THE CORRECT TYPE OR CALIBER OF AMMUNITION MAY CAUSE THE FIREARM TO JAM, FAIL TO FIRE, OR MAY GENERATE EXCESSIVE PRESSURE WHICH CAN DAMAGE OR EVEN RUPTURE YOUR FIREARM, CAUSING PERSONAL INJURY OR DEATH TO THE SHOOTER OR BYSTANDERS.

- Locate the cartridge designation marked on the firearm's barrel. This information indicates the correct ammunition that must be used in your firearm (FIGURE 1).
- You are responsible for selecting ammunition that meets industry standards and is appropriate in type and caliber for this firearm.
- Never mix ammunition.

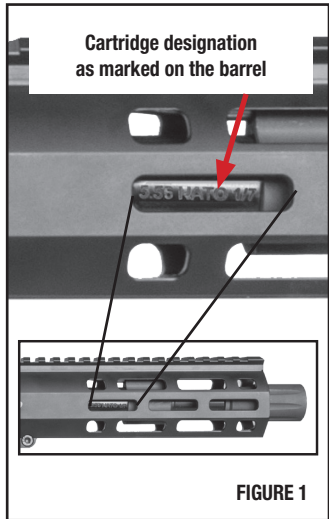

ALTERNATE AMMUNITION: Select cartridges can be used in firearms so marked from the following list:

Caliber Marked On The Barrel	Can Also Fire
5.56 NATO	223 REM



WARNING: IN SOME CASES, A ROUND OF AMMUNITION NOT SPECIFIED ON YOUR FIREARM AND NOT LISTED AS ALTERNATE AMMUNITION IN THIS MANUAL, MAY FIT INTO THE CHAMBER. FIRING THIS AMMUNITION MAY CAUSE A RUPTURE RESULTING IN DAMAGE TO THE FIREARM AND PERSONAL INJURY OR DEATH TO THE SHOOTER OR BYSTANDERS. FOR MORE INFORMATION REGARDING UNSAFE CALIBER COMBINATIONS, REFER TO THE FOLLOWING URL: [HTTPS://SAAMI.ORG/TECHNICAL-INFORMATION/UNSAFE-FIREARM-AMMUNITION-COMBINATIONS/](https://saami.org/technical-information/unsafe-firearm-ammunition-combinations/)

AMMUNITION CONTINUED



WARNING: ALWAYS INSPECT YOUR AMMUNITION BEFORE USING IT. NEVER USE DIRTY, CORRODED OR DAMAGED AMMUNITION. A BURST CARTRIDGE MAY RESULT CAUSING DAMAGE TO THE FIREARM AND PERSONAL INJURY OR DEATH TO THE SHOOTER OR BYSTANDERS.



WARNING: NEVER USE NON-STANDARD, RELOADED OR “HANDLOADED” AMMUNITION WHICH HAS NOT BEEN SUBJECTED TO INTERNAL BALLISTIC PRESSURE TESTING. RELOADED OR HANDLOADED AMMUNITION, MAY HAVE MANY MANUFACTURING AND QUALITY VARIABLES (SUCH AS THE TYPE AND AMOUNT OF GUN POWDER). CARTRIDGE CASES THAT HAVE BEEN RELOADED AND FIRED MULTIPLE TIMES MAY SUFFER PHYSICAL DAMAGE WHICH COULD SIGNIFICANTLY IMPACT OR REDUCE THE INTEGRITY OF THE CARTRIDGE, POSSIBLY RESULTING IN BULLET SET-BACK OR UNSEATING. CASE FAILURE AND INJURY TO THE SHOOTER OR BYSTANDERS AND DAMAGE TO THE FIREARM MAY RESULT WHEN SUCH A ROUND IS FIRED. ANY AMMUNITION THAT IS IMPROPERLY MANUFACTURED OR RELOADED, EVEN IN THE SLIGHTEST DEGREE, MAY FAIL TO FIRE OR MAY GENERATE EXCESSIVE INTERNAL PRESSURES WHICH CAN DAMAGE OR EVEN RUPTURE THE FIREARM, CAUSING PERSONAL INJURY OR DEATH TO THE SHOOTER OR THOSE IN THE IMMEDIATE VICINITY.



WARNING: DISCHARGING FIREARMS IN POORLY VENTILATED AREAS, CLEANING FIREARMS, OR HANDLING AMMUNITION MAY RESULT IN EXPOSURE TO LEAD AND OTHER SUBSTANCES KNOWN TO CAUSE BIRTH DEFECTS, REPRODUCTIVE HARM, AND OTHER SERIOUS PHYSICAL INJURY. HAVE ADEQUATE VENTILATION AT ALL TIMES. WASH HANDS THOROUGHLY AFTER EXPOSURE.



WARNING: NEVER USE AMMUNITION OF THE INCORRECT GAUGE OR CALIBER. USING AMMUNITION OF THE INCORRECT GAUGE OR CALIBER MAY CAUSE DAMAGE TO YOUR FIREARM AND POSSIBLE SERIOUS INJURY TO YOU AND TO OTHERS.



WARNING: NEVER USE CARTRIDGES OTHER THAN THOSE DESIGNATED BY THE MARKING ON THE FIREARM. DOING SO CAN RESULT IN DANGEROUSLY HIGH PRESSURES THAT MAY DAMAGE THE FIREARM AND POSSIBLY CAUSE SERIOUS INJURY TO YOURSELF AND OTHERS.



WARNING: DEATH, SERIOUS INJURY AND PROPERTY DAMAGE CAN RESULT FROM THE USE OF INCORRECT AMMUNITION OR BORE OBSTRUCTIONS. NEVER USE RELOADED AMMUNITION THAT HAS NOT BEEN SUBJECTED TO INTERNAL BALLISTIC PRESSURE TESTING.

AMMUNITION CONTINUED

- A firearm and ammunition are a system and must work together. There are different types of ammunition for different types of firearms. Your firearm has been designed for ammunition of a specific type and a specific gauge or caliber. It is important to select the proper ammunition for your firearm.
- Different combinations of bullet velocity, bullet weight and firearm weight can have major impact on felt recoil; high felt recoil can be uncomfortable to some shooters.

CAUTION: Use of ammunition manufactured with corrosive primers in this firearm will cause oxidation to develop on the metal parts of the firearm. To prevent such oxidation, the residue from corrosive primers must be completely removed from all metal parts after each time ammunition with corrosive primers is used in this firearm. Conventional oil or solvent-based firearm cleaners WILL NOT dissolve the residue from corrosive primers. Residue from corrosive primers MUST be completely dissolved with a water-based cleaner. After the corrosive residue has been completely dissolved from all metal parts, remove all of the water-based cleaner from the firearm and get the metal parts dry. Finally, lubricate the firearm as instructed in this manual. Failure to follow these instructions will cause serious damage to the firearm and may affect the ability of the firearm to function properly.

- Check with the ammunition manufacturer or a qualified gunsmith if you are unsure whether the particular ammunition you plan to use in this firearm has been manufactured with corrosive primers. If in doubt, follow all the instructions above to prevent oxidation caused by ammunition manufactured with corrosive primers.
- Ammunition manufactured by SAAMI member companies do not use corrosive primers.

MODEL AND FEATURES IDENTIFICATION

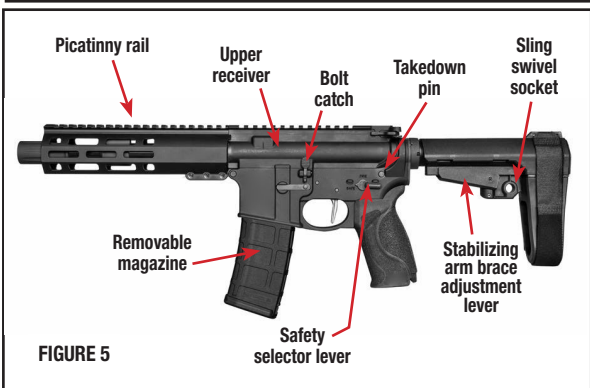
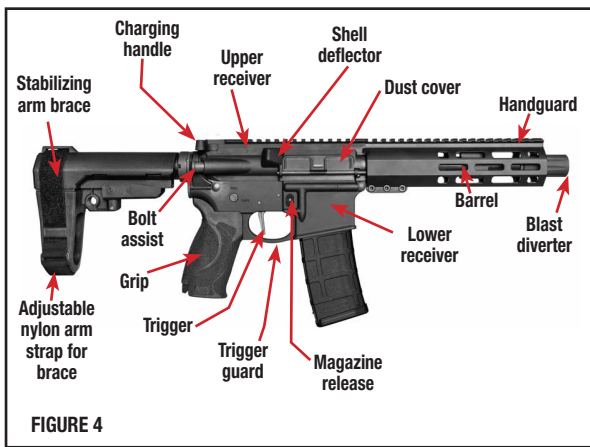
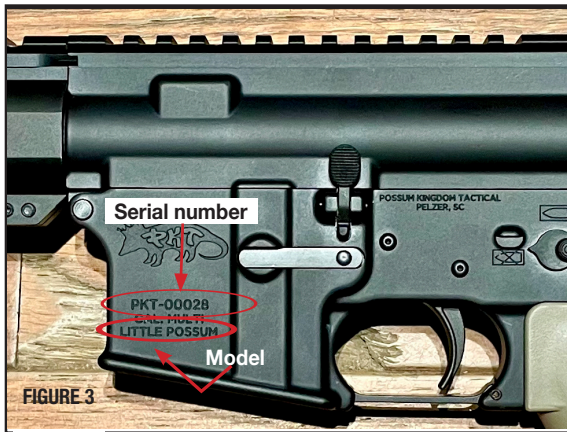

INSPECTING YOUR firearm



WARNING: ALWAYS KEEP THE MUZZLE POINTED IN A SAFE DIRECTION.



WARNING: ALWAYS ENSURE THAT THE FIREARM IS UNLOADED BEFORE INSPECTING, DISASSEMBLING, ASSEMBLING OR CLEANING.

- PKT ARs are semi-automatic, magazine-fed repeating firearms.
- When you inspect your PKT firearm, you should first check for yourself to ensure that it is unloaded. Never take anyone's word for it.
- As shipped from the factory, an empty chamber flag is used to indicate that no round of ammunition is present in the chamber (FIGURE 6). The magazine is packaged separately in the gun box. **NOTE:** When handling PKT firearms; if the safety selector does not easily rotate to the "SAFE" position, DO NOT attempt to force it

into "SAFE." While keeping the muzzle pointed in a safe direction, remove the magazine from the firearm and lock your bolt open as instructed in the following steps and then rotate the safety selector to "SAFE" before proceeding.

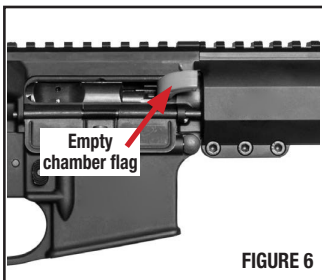

NOTE: Pull the charging handle by both sides uniformly. The left side contains the lock that keeps the charging handle locked forward when it's not in use (FIGURE 7).



- Grasp the firearm with your finger off the trigger and outside the trigger guard, point the muzzle in a safe direction, open the action by grasping the charging handle (depressing the locking device on the left side) and drawing it rearward (FIGURE 8).

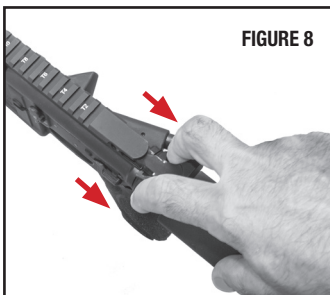

INSPECTING YOUR FIREARM CONTINUED

- Draw the charging handle fully rearward (FIGURE 9) and while holding it there against spring tension, press in on the bottom of the bolt stop (FIGURE 10). While pressing the bolt stop, let the charging handle move forward slightly until it engages the bolt stop.
- Return the charging handle to its forward position where the lock engages the receiver (FIGURE 11).
- Remove the empty chamber flag from the firearm (FIGURE 12).
- Look into the receiver and check chamber to be sure no cartridges are visible (FIGURE 13).
- You must follow this procedure every time a firearm leaves your hand, is cleaned, handed to you or another person, transported or stored.
- Before using your firearm for the first time, it should be cleaned. See the section of this manual regarding Cleaning and Maintenance.

 **WARNING: NEVER RELY ON MECHANICAL FEATURES ALONE. ONLY YOUR SAFE FIREARM HANDLING WILL ENSURE THE SAFE USE OF YOUR FIREARM. THIS IS YOUR RESPONSIBILITY.**

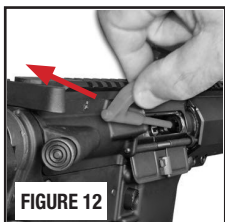
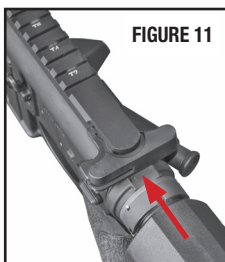
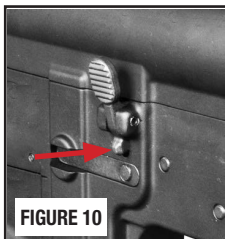

PREPARATION FOR FIRING



WARNING: THE FAILURE TO FOLLOW THESE FIREARM SAFETY REQUIREMENTS WILL CAUSE SERIOUS PERSONAL INJURY OR DEATH TO YOU OR OTHERS.

- **ALWAYS TREAT ALL FIREARMS AS IF THEY ARE LOADED.**
- **ALWAYS BE SURE THAT ALL ACTIONS OF FIREARMS ARE OPEN, THAT CHAMBERS ARE CLEAR OF CARTRIDGES AND MAGAZINES ARE REMOVED OR UNLOADED, AND THAT FIREARM IS POINTING IN A SAFE DIRECTION.**
- **ALWAYS KEEP FINGERS AND OTHER BODY PARTS AWAY FROM THE MUZZLE AND AWAY FROM THE EJECTION PORT.**
- **ALWAYS WEAR ADEQUATE AND PROPER HEARING PROTECTION SPECIFIED FOR FIREARM USE** to prevent permanent damage to your hearing. Make sure others who are nearby are wearing hearing protection as well.
- **ALWAYS WEAR SAFETY GLASSES SPECIFIED FOR FIREARM USE,** whether indoors or out. Safety glasses should protect your eyes from the firing flash and particles associated with the discharge of ammunition. Failure to do so creates a risk of personal injury from particle or debris spitting or from a ricochet.
- **ALWAYS BE ALERT AND ALWAYS FOLLOW THE SAFETY INSTRUCTIONS OF THE RANGE OFFICER.** Never shoot if you are tired, cold or impaired in any way.
- **ALWAYS BE AWARE OF OTHER PEOPLE** so that persons do not accidentally walk into the line of fire.
- **THE SHOOTER (AND ALL OTHERS IN THE SHOOTING AREA) MUST ALWAYS BE IN A POSITION THAT IS OUT OF THE LINE OF FIRE** and are not within an area where they may be struck by a ricochet or particles spitting from a firearm, or by ejected cases from some types of firearms.
- **NEVER SHOOT AT SURFACES THAT MAY CAUSE A RICOCHET.** Always select a place to shoot that has a safe backstop, is free from obstructions and has no surfaces that may cause a ricochet.
- **NEVER FIRE RANDOMLY INTO THE SKY.** Always select a place to shoot that has a safe backstop.
- **NEVER USE ALCOHOL OR DRUGS BEFORE OR WHILE SHOOTING OR HANDLING ANY FIREARM.**

LOADING



WARNING: ALWAYS POINT THE MUZZLE IN A SAFE DIRECTION.

- Do not load the firearm until you have read and fully understand this manual.
- Do not load the firearm until you are ready to use it. Keep your finger off the trigger and outside the trigger guard until you are ready to fire.
- Never load your firearm until you are sure of your target, what is beyond it and are fully prepared to fire.
- If a magazine is present in the firearm, press the magazine release and remove the magazine from the firearm (FIGURE 14).
- Pull the charging handle all the way back and while holding it, press the bottom of the bolt catch down and release pressure on the charging handle. This will lock the bolt in the open position (FIGURES 15 and 16).
- Return charging handle fully forward until it locks and remove finger from bolt catch.
- Set safety selector lever to “SAFE” (FIGURE 17).

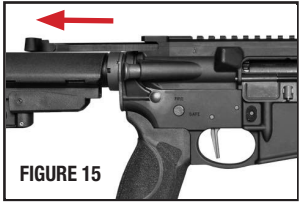
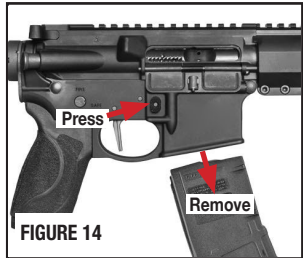

WARNING: DO NOT CARRY THIS FIREARM WITH THE BOLT OPEN AND A LOADED MAGAZINE IN THE PISTOL. AN ACCIDENTAL DISCHARGE MAY RESULT IF THE BOLT CLOSSES AND THE SAFETY LEVER IS NOT IN THE “SAFE” POSITION, LEADING TO DEATH OR INJURY TO THE SHOOT-ER OR BYSTANDERS AND DAMAGE TO PROPERTY.

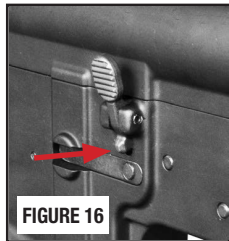

LOADING CONTINUED

- PKT has provided you with a magazine designed to operate in your specific model of firearm. While your magazine may be able to be inserted into another model firearm, it will only function properly in the specific model for which it was designed. Do not interchange magazines from one model firearm to another model firearm.

- Orient the magazine as shown (FIGURE 18) and place a round between the lips of the magazine with the bullet pointing forward. Press the round down and back until it is held by the magazine lips. Slide the next round in on top of the previous round and repeat until the desired number of rounds is loaded (FIGURE 19).



FIGURE 18

- Follow instructions in this manual and any other specific instructions which may be marked onto, or accompany the magazine. Failure to use the particular type of PKT magazine specified for your model and caliber of firearm may result in a malfunction.

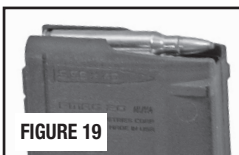

FIGURE 19

- With the bullet end of the cartridge pointing forward (FIGURE 20), insert the load- magazine into magazine well of the firearm until it is securely locked in place. Check placement by putting downward pressure on magazine.



20

WARNING: THIS FIREARM MAY DISCHARGE ACCIDENTALLY WHEN A ROUND IS FED INTO THE CHAMBER, IF IT IS DROPPED OR RECEIVES A BLOW TO THE MUZZLE OR FRONT OF THE FIREARM. THIS CAN OCCUR REGARDLESS OF THE POSITION OF THE HAMMER OR ANY OF THE VARIOUS SAFETY DEVICES. THEREFORE, EXTRA CARE AND STRICT ADHERENCE TO THESE INSTRUCTIONS BY THE FIREARM USER IS MANDATORY FOR MINIMIZING THE RISK OF ACCIDENTS.

WARNING: ALWAYS POINT THE MUZZLE IN A SAFE DIRECTION WHEN YOU RELEASE THE BOLT.

LOADING CONTINUED

- Keep your fingers away from the ejection port. With the muzzle pointing in a safe direction, press in on the top of the bolt catch to release the bolt and carrier (FIGURE 21), which will move forward under spring pressure and feed a round from the magazine into the chamber.

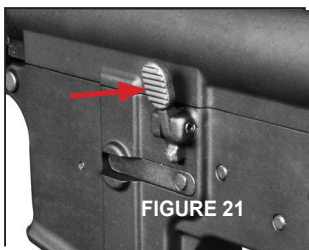

- The firearm is now loaded and will fire if the safety selector lever is set on “FIRE” and the trigger is pulled.
- If the bolt does not completely close, press the bolt assist (FIGURE 22). This should move the bolt completely forward. If your firearm is not equipped with a bolt assist or the bolt assist does not chamber a round, see the Clearing Misfires section of this manual.



- You may now manually close the ejection port dust cover by raising it and “clicking” it into the closed position - covering the bolt (FIGURE 23).



WARNING: IF THE CARTRIDGE FAILS TO STRIP FROM THE MAGAZINE OR FULLY SEAT INTO THE CHAMBER, IMMEDIATELY STOP THE LOADING PROCESS. REMOVE THE MAGAZINE, LOCK THE ACTION OPEN AND VERIFY THAT THE CHAMBER IS EMPTY. REFER TO THE “INSPECTING YOUR FIREARM” SECTION OF THIS MANUAL.

WARNING: ALWAYS LOAD A ROUND INTO THE CHAMBER BY FEEDING IT FROM THE MAGAZINE. NEVER ATTEMPT TO LOAD THE FIREARM BY INSERTING A ROUND INTO THE CHAMBER THROUGH THE EJECTION PORT WITH (OR WITHOUT) THE MAGAZINE IN THE FIREARM. FAILURE TO FOLLOW THIS WARNING CAN RESULT IN SEVERE INJURY OR DEATH TO THE SHOOTER OR BYSTANDERS.

WARNING: NEVER STRIKE OR DROP THE FIREARM. DOING SO MAY CAUSE A ROUND TO CHAMBER. AN ACCIDENTAL DISCHARGE MAY RESULT IF THE BOLT CLOSES AND A ROUND IS CHAMBERED, LEADING TO DEATH OR INJURY TO THE SHOOTER OR BYSTANDERS AND DAMAGE TO PROPERTY.

LOADING CONTINUED



WARNING: PKT FIREARMS WILL FIRE WITH THE MAGAZINE REMOVED. KEEP YOUR FINGER OFF THE TRIGGER AND OUTSIDE THE TRIGGER GUARD UNTIL YOU HAVE MADE THE COMMITMENT TO FIRE.

FIRING



WARNING: ALWAYS KEEP THE MUZZLE POINTED IN A SAFE DIRECTION.



WARNING: WEAR EYE AND HEARING PROTECTION SPECIFIED FOR FIREARM USE EVERY TIME YOU DISCHARGE YOUR FIREARM. MAKE SURE OTHERS IN THE VICINITY OF WHERE YOU WILL BE SHOOTING DO SO AS WELL.

• For PKT AR pistols:

- Open the adjustable nylon strap on the stabilizing arm brace, insert hand through the stabilizing arm brace opening and grasp firearm by the grip with index finger resting along outside of trigger guard. Draw strap snug around forearm and close.
- Raise firearm and aim carefully (FIGURE 25).
- Rotate the safety selector to the “FIRE” position (FIGURE 26).
- Keeping a steady aim, place index finger on trigger and pull gently until the firearm fires. The firearm chambers the next round immediately after firing.
- You may continue to fire by pulling and fully releasing the trigger between shots until the magazine is empty.
- If you wish to stop firing, release trigger, remove finger from trigger guard, and set safety selector to “SAFE” (FIGURE 27). If you have fired the last round from the magazine, the bolt will be held to the rear so that the firearm can quickly be reloaded by replacing the magazine, or the chamber can be inspected to ensure that it is empty.



FIGURE 24



FIGURE 25



FIGURE 26

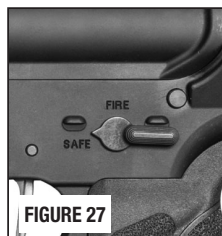

FIGURE 27

HANGFIRES AND MISFIRES



WARNING: ALWAYS KEEP THE MUZZLE POINTED IN A SAFE DIRECTION.



WARNING: WEAR EYE AND HEARING PROTECTION SPECIFIED FOR USE WITH FIREARMS WHEN FIRING AND CLEARING MISFIRES OR MISFEEDS.



WARNING: KEEP YOUR FACE A SAFE DISTANCE FROM THE EJECTION PORT WHEN CLEARING A CARTRIDGE. IF A CARTRIDGE IGNITES WHILE BEING CLEARED FROM THE FIREARM, DEATH OR SERIOUS INJURY MAY RESULT.



WARNING: IF YOUR FIREARM GIVES ANY INDICATION THAT IT IS NOT PERFORMING PROPERLY OR THE OPERATION OF YOUR FIREARM HAS CHANGED “THE WAY IT FEELS OR SOUNDS”, STOP FIRING. MAKE SURE THE FIREARM IS POINTED IN A SAFE DIRECTION, UNLOAD THE FIREARM AND HAVE IT INSPECTED AND TEST FIRED BY A GUNSMITH QUALIFIED TO PERFORM SERVICES ON PKT FIREARMS.

NOTE: In the case of either a hangfire or misfire, keep the muzzle pointed in a safe direction and your finger off the trigger. Wait 60 seconds, then press the magazine release button (FIGURE 28) and remove the magazine from the firearm (FIGURE 29). Proceed to clear the unfired cartridge from the chamber.

- **A HANGFIRE** is described as a noticeable delay between the impact of the firing pin on the primer of the cartridge and the actual discharge of the firearm. This is generally caused by defective or damaged ammunition.
- If a cartridge has delayed ignition and goes off after a delay, with the firearm pointed in a safe direction, the magazine should be removed and the firearm should be unloaded. The remainder of similar ammunition should be inspected to determine if it has been contaminated or damaged and dealt with accordingly.
- **A MISFIRE** is the failure of the chambered cartridge to fire at all after the trigger has been pulled. This is generally caused by defective or damaged ammunition or a dirty or fouled firearm.
- A light primer strike caused by a dirty or fouled firearm can lead to misfires. If a light indent on the primer of a misfire is noted, unload the firearm and clean it as instructed in the Cleaning and Maintenance section of this manual. If the cartridge does not go off, the “dud” cartridge needs to be removed from the firearm.

HANGFIRES AND MISFIRES CONTINUED

- Pull the charging handle all the way back (FIGURE 30) and press the lower portion of the bolt catch down then let the bolt move forward against the bolt catch (FIGURE 31). This will lock the bolt in the open position. Remove your finger from bolt catch. Return the charging handle fully forward until it locks.



- Rotate the safety lever to the SAFE position (FIGURE 32).



- Visually check the chamber to be sure no cartridges are present (FIGURE 33).

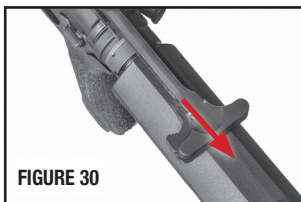

- The firearm should be inspected and cleaned before returning it to use.

- The ammunition should be inspected and damaged or defective rounds should not be used.

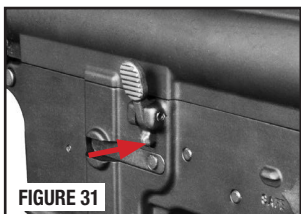

- Damaged or defective ammunition should be disposed of properly.

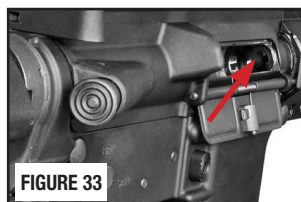

CLEARING A MISFEED/JAM

NOTE: Any autoloading firearm may, on occasion, fail to feed a cartridge properly from the magazine and into the chamber. If this should occur:



WARNING: KEEP YOUR FACE A SAFE DISTANCE FROM THE EJECTION PORT WHEN CLEARING A MISFED/JAMMED CARTRIDGE. A CARTRIDGE MAY IGNITE IF THE PRIMER OF THE CARTRIDGE IS STRUCK WITH SUFFICIENT FORCE. IF A CARTRIDGE IGNITES WHILE BEING CLEARED FROM THE FIREARM, DEATH OR SERIOUS INJURY MAY RESULT.

TO CLEAR A MISFEED (“JAM”)

- Be certain the muzzle is pointed in a safe direction.
- Press the magazine release and remove the magazine (FIGURE 34).
- Pull the charging handle back and lock the bolt open with the bolt stop (FIGURES 35 and 36).

NOTE: Drawing the bolt fully to the rear should allow clearance for the jammed cartridge to fall free and clear of the firearm.

- Rotate the safety lever into the “SAFE” position (FIGURE 37).
- It may be necessary to manually remove a jammed cartridge. When attempting to clear a jam manually, use only wood ‘tools’, such as a pointed dowel or a pencil, and use extreme care to avoid striking the primer of the cartridge.
- Visually check to make sure all cartridges have been removed from the firearm.
- Once the misfed cartridge is cleared, proceed to load the firearm as instructed in the Loading Section of this manual.
- Dispose of defective cartridge(s) in a method specifically approved for live round disposal.



FIGURE 34

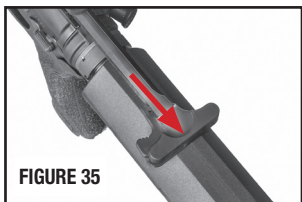

FIGURE 35

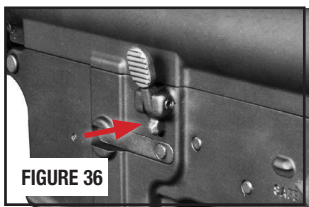

FIGURE 36



FIGURE 37

UNLOADING



WARNING: ALWAYS KEEP THE MUZZLE POINTED IN A SAFE DIRECTION.

- Press magazine release and remove magazine (FIGURE 38).
- Pull charging handle to rear and push in lower portion of bolt catch to hold bolt open (FIGURES 39 and 40).
- Set safety selector lever to "SAFE" (FIGURE 41).
- Look into the chamber through ejection port to ensure that the chamber is empty (FIGURE 42).
- Remove remaining live rounds from the magazine by sliding them forward and out of the magazine (FIGURE 43).
- Collect live ammunition for safe storage and spent cartridge cases for disposal.

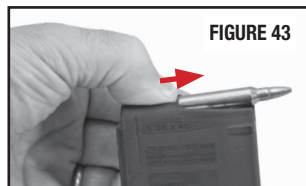
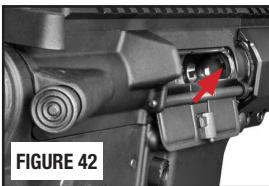
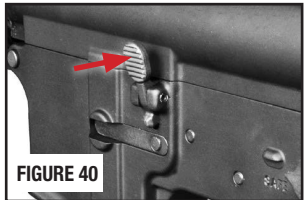
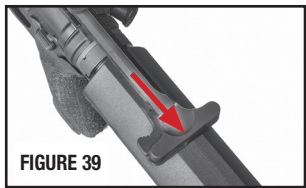

DISASSEMBLY/FIELD STRIPPING



WARNING: ALWAYS KEEP THE MUZZLE POINTED IN A SAFE DIRECTION.



WARNING: NEVER DO ANYTHING BEYOND WHAT YOU ARE SPECIFICALLY INSTRUCTED TO DO IN THIS MANUAL. NEVER ALTER OR MODIFY THE PARTS IN YOUR FIREARM.

DISASSEMBLY - FIELD STRIPPING CONTINUED



WARNING: WEAR SAFETY GLASSES THAT ARE SPECIFIED FOR FIREARMS USE EVERY TIME YOU ASSEMBLE OR DISASSEMBLE YOUR FIREARM.



WARNING: ANY MAINTENANCE, ADJUSTMENT OR SERVICE NOT SPECIFIED IN THIS MANUAL MAY AFFECT THE SAFETY AND RELIABILITY OF YOUR FIREARM AND MUST BE PERFORMED BY A QUALIFIED GUNSMITH USING GENUINE PKT PARTS. IF YOU DO OTHERWISE, IMPROPER FUNCTIONING OF YOUR FIREARM MAY OCCUR AND SERIOUS INJURY OR DEATH MAY RESULT.

- Press the magazine release button and remove the magazine from the firearm and ensure that the firearm is not loaded (FIGURE 44).



- Rotate the safety lever to the "SAFE" position (FIGURE 45).



- Look into the chamber and verify that there is no ammunition present (FIGURE 46).

NOTE: When handling PKT firearms;

if the safety does not easily rotate to the "SAFE" position, DO NOT attempt to force it into "SAFE." While keeping the muzzle pointed in a safe direction, remove the magazine and lock your bolt open and then rotate the safety selector to "SAFE" before proceeding.

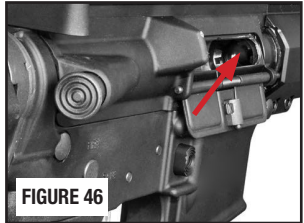

- Push the top of the bolt release to ensure that the bolt is in the forward position (FIGURE 47).

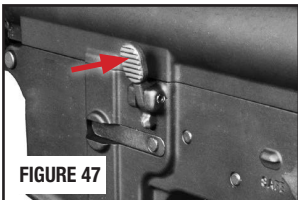

DISASSEMBLY - FIELD STRIPPING CONTINUED

- Push in take down pin above and behind the trigger (FIGURE 48) from the left side and pull the pin out on the right side of the receiver until it comes to a positive stop (FIGURE 49).



- Pivot lower receiver down and away from upper receiver (FIGURE 50). **CAUTION:** Never dry-fire a PKT firearm when it is disassembled. Damage to the firearm may result.

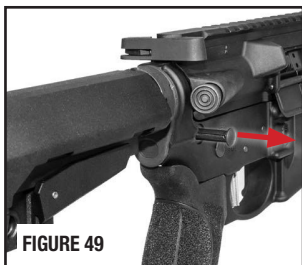

- If required, remove pivot pin from the front of receiver (FIGURE 51) (in a similar manner to the rear pin) and separate the upper receiver from the lower receiver completely.



- Pull the charging handle to rear and remove bolt carrier assembly (FIGURE 52).

- Remove charging handle from the upper receiver by pulling it backwards to the takedown notch and then down out of the upper receiver (FIGURE 52).

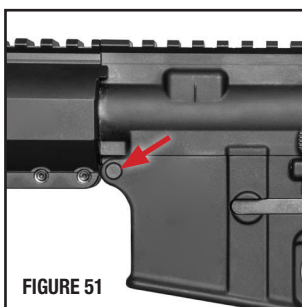

- FIGURE 53 shows the charging handle takedown notch (as seen from the bottom of the upper receiver).

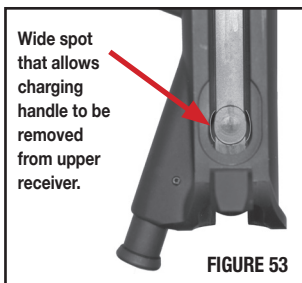
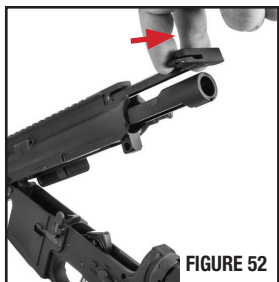

DISASSEMBLY - FIELD STRIPPING CONTINUED

- FIGURES 54 through 56 show the bolt assembly (bolt carrier and the bolt) and the charging handle being removed from the upper receiver and both parts removed.

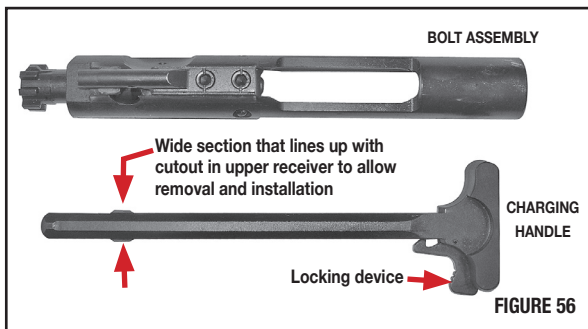
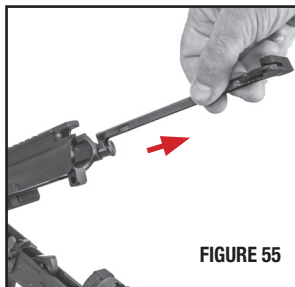
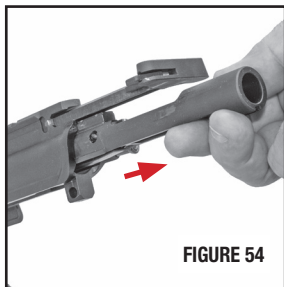

SPECIAL COMPONENT DISASSEMBLY



WARNING: ALWAYS ENSURE THAT THE FIREARM IS UNLOADED BEFORE ANY PROCEDURE IS ATTEMPTED.



WARNING: WEAR SAFETY GLASSES EVERY TIME YOU ASSEMBLE OR DISASSEMBLE YOUR FIREARM.

HANDGUARD REMOVAL - PKT FIREARMS

- Remove the three (3) hex-head screws that clamp the forend to the barrel nut, using a 5/32" wrench (FIGURE 57a).

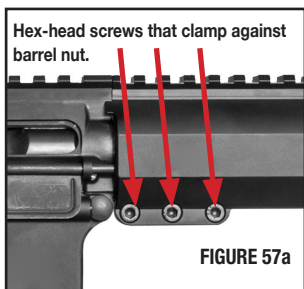

SPECIAL COMPONENT DISASSEMBLY CONT'D

- Loosen the two (2) hex-head set screws that lock the forend against the barrel nut (FIGURE 57b), using a 5/64" wrench.
- Remove the handguard by sliding it forward and off of the barrel.

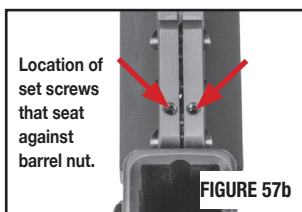

FIELD STRIPPING THE BOLT

- Push the rear takedown pin out and tip the upper receiver open as instructed previously in this manual (FIGURE 58).
- Pull back on the charging handle and bolt assembly (FIGURE 59).



- Remove the bolt carrier assembly from the upper receiver.
- Pull the charging handle back and down to remove it from the upper receiver.
- Once the bolt carrier is clear of the firearm, move the bolt forward in the carrier to the unlocked position (FIGURE 60) and remove the firing pin retaining pin (FIGURE 61). Do not alter the split end of the firing pin retaining pin.
- Push the bolt into the bolt carrier to put it in the locked position (FIGURE 62).
- Remove the firing pin out of the rear of the bolt carrier (FIGURE 63).

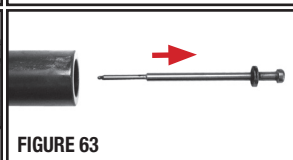
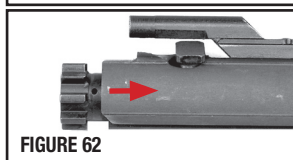
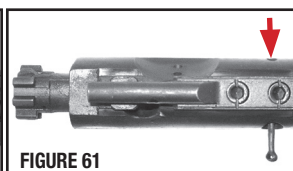
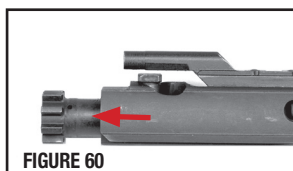

SPECIAL COMPONENT DISASSEMBLY CONT'D

- Turn the bolt cam pin a 1/4 turn and lift it out (FIG. 64).
- Remove the bolt from the bolt carrier (FIGURE 65).
- Press the rear of the extractor to check that the spring works. (FIGURE 66) If there is no tension, you must take the extractor apart and clean the parts.
- Use a drift/pen tip to remove the extractor pin.
- Remove the extractor from the bolt. Do not remove the rubber grommet from the spring. (FIGURE 67).

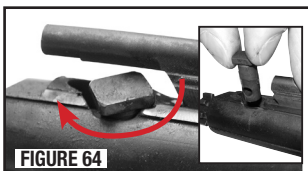

FIGURE 64



FIGURE 65



FIGURE 66

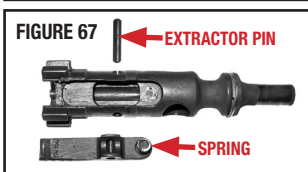

FIGURE 67 ← EXTRACTOR PIN

← SPRING

WARNING: DO NOT DISASSEMBLE THE EXTRACTOR OR THE SPRING ASSEMBLY.

FIELD STRIPPING THE BUFFER AND SPRING

- Push in buffer (at the rear of the receiver / front of the stabilizing arm brace) slightly and depress buffer retainer to release the buffer (FIGURE 68).
- Remove buffer and spring from the buffer tube (FIGURE 69).



FIGURE 68



FIGURE 69

WARNING: DO NOT ALTER, MODIFY OR REPLACE ANY OF THE PARTS OF YOUR FIREARM UNLESS THIS WORK IS PERFORMED BY A QUALIFIED GUNSMITH USING GENUINE PKT PARTS. IF YOU DO OTHERWISE, IMPROPER FUNCTIONING MAY OCCUR AND SERIOUS INJURY MAY RESULT.

WARNING: NEVER DISASSEMBLE YOUR FIREARM BEYOND THE FIELD STRIPPING PROCESS OUTLINED IN THIS MANUAL. NEVER MANIPULATE ANY INTERNAL COMPONENTS BEYOND WHAT YOU ARE SPECIFICALLY INSTRUCTED TO DO IN THIS MANUAL SINCE THIS MAY AFFECT THE RELIABILITY, FUNCTIONING AND SAFETY OF YOUR FIREARM.

ASSEMBLY



WARNING: ALWAYS FOLLOW THE FIELD STRIPPING INSTRUCTIONS EXACTLY. NEVER DO ANYTHING BEYOND WHAT YOU ARE SPECIFICALLY INSTRUCTED TO DO IN THIS MANUAL. NEVER ALTER OR MODIFY THE PARTS IN YOUR FIREARM.



WARNING: WEAR SAFETY GLASSES EVERY TIME YOU ASSEMBLE OR DISASSEMBLE YOUR FIREARM.

- Assemble your PKT firearm in the reverse order that you took it apart.
- Make sure that the gaps of the gas rings on the bolt are not aligned when reassembling (FIGURE 70).

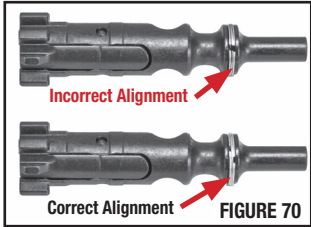

- Lubricate all metal parts by wiping them with a cloth dampened with a high quality firearm oil. Remove excess oil. Leave a light film of oil on all metal parts of your firearm - inside and out.

STABILIZING ARM BRACE (PKT AR pistols, only)

- To extend the adjustable stabilizing arm brace, depress lever (FIGURE 71a) and pull the stabilizing arm brace backward to the desired position and then release the lever, allowing it to lock into its new position.
- To collapse the adjustable stabilizing arm brace, depress the lever to unlock, push forward until it locks into position and then release.

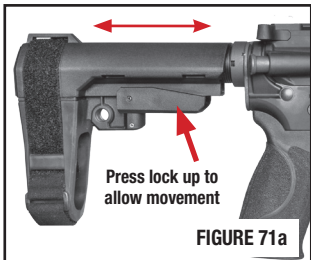

FIGURE 71b



FIGURE 71c

- FIGURES 71b, 71c and 71d show the adjustable nylon arm strap and how to deploy it while firing.



FIGURE 25

INSTALLATION OF OPTICS



WARNING: ALWAYS ENSURE THAT THE FIREARM IS UNLOADED BEFORE INSTALLING A SCOPE, OPTICAL SIGHT OR ANY OTHER ACCESSORIES. FAILURE TO DO THIS CAN RESULT IN INJURY OR DEATH TO YOU OR OTHERS AND DAMAGE TO PROPERTY.

- We recommend that you have a competent gunsmith install your optic, scope and mount or sights.
- Scopes and optical sights have varying lengths of recommended eye relief. You need to choose a combination that allows for adequate clearance between the scope and your eye brow. Follow the instructions supplied with the scope and rings for proper installation.



WARNING: FIRING A FIREARM WITH YOUR EYE TOO CLOSE TO THE EYE PIECE OF A SCOPE OR OPTICAL SIGHT, OR FAILING TO HOLD THE FIREARM SECURELY AGAINST RECOIL MAY RESULT IN SERIOUS PERSONAL INJURY INCLUDING, BUT NOT LIMITED TO, BLINDNESS.



WARNING: A SCOPE OR OPTICAL SIGHT WHICH IS NOT SECURELY MOUNTED MAY BECOME DETACHED UPON RECOIL OF THE FIREARM. IF IT BECOMES DETACHED IT MAY FLY BACK AND STRIKE THE SHOOTER OR A BYSTANDER AND CAUSE INJURY. OBSERVE THE CONDITION OF ALL THE SCOPE MOUNT SCREWS AFTER FIRING. IF THE MOUNTING SCREWS SHOW SIGNS OF LOOSENING DO NOT FIRE THE GUN AGAIN; CALL THE CUSTOMER SERVICE DEPT. FOR ASSISTANCE AT 864-921-0472 or 864-360-5147.



MAGAZINE



WARNING: WEAR SAFETY GLASSES EVERY TIME YOU ASSEMBLE OR DISASSEMBLE YOUR MAGAZINE.

- FIGURE 73 shows the parts that make up the magazine.

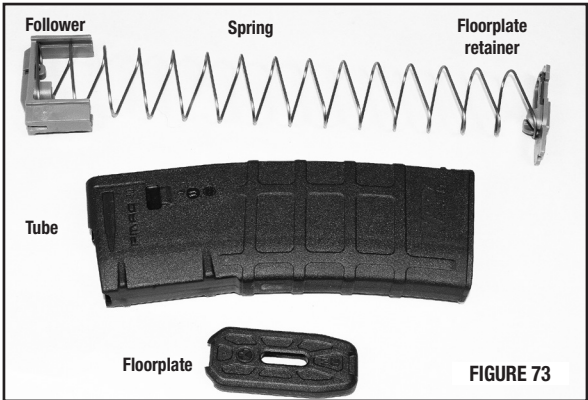

FIGURE 73

MAGAZINE DISASSEMBLY

- Using a small blunt object (such as an allen wrench), push the floorplate retainer down by passing the tool through the hole in the floorplate (FIGURE 74).
- While holding the retainer down - slide floorplate forward off of the tube while keeping your finger over the tube to prevent the spring from flying out (FIGURE 75).



FIGURE 74

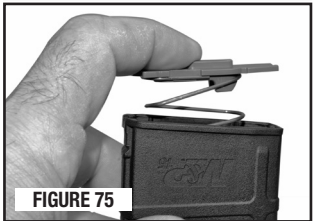

FIGURE 75



WARNING: MAGAZINE SPRING IS UNDER PRESSURE. CONTROL THE SPRING AND THE FLOOR PLATE RETAINER SO THAT THEY DO NOT FLY OUT AND CAUSE INJURY.

- Remove floorplate retainer, spring and the follower out through bottom of the magazine tube.

MAGAZINE REASSEMBLY

- Install the follower and spring into the magazine tube.
- While holding the spring down (under tension) in the tube, slide the floorplate onto the magazine tube (over the tabs) until the floorplate locks it into place.

CLEANING AND MAINTENANCE



WARNING: ENSURE THAT YOUR FIREARM IS UNLOADED BEFORE BEGINNING TO CLEAN IT. ALWAYS FOLLOW THE RULES OF SAFE FIREARM HANDLING.



WARNING: WEAR SAFETY GLASSES EVERY TIME YOU ASSEMBLE OR DISASSEMBLE YOUR FIREARM AND ATTEMPT CLEANING OR MAINTENANCE.

- Before using your firearm for the first time, it should be cleaned.
- Your firearm was treated at the factory with either a preservative or oil to protect it against corrosion during shipping and storage.
- Preservative and oil should be wiped from the bore, chamber and exposed areas using a clean swab or patch before using the firearm.

CAUTION: Never disassemble your firearm beyond the instructions in the Field Stripping and Inspection sections of this manual.

- Purchase cleaning supplies from your firearms dealer that are specifically designated for your type and caliber of firearm. Many suppliers offer these in kit form for your convenience.
- Follow the instructions provided with your cleaning supplies.

NOTE: A basic firearm cleaning kit should include: a brass bore brush and a cleaning jag of appropriate size for the bore being cleaned, high-quality gun cleaning solvent and gun oil/lubricant, cotton cleaning patches and a cleaning rod that is long enough to push the brush and jag completely through the barrel.

- Remove excessive firing residue from the bore and chamber using a properly fitted brass brush dipped in gun cleaning solvent. Finish the bore cleaning process by running a dry cotton cloth patch through the bore and chamber to remove residue and solvent.
- Clean the exterior of the firearm using a non-abrasive cleaning cloth.
- After cleaning, lightly coat the metal parts, internal and external with a high quality firearm oil.
- Whenever your firearm has been exposed to sand, dust, extreme humidity, water or other adverse conditions, it must be cleaned and lubricated.

CLEANING AND MAINTENANCE CONTINUED



WARNING: ALWAYS HAVE ADEQUATE VENTILATION. CLEANING FIREARMS IN POORLY VENTILATED AREAS, DISCHARGING FIREARMS, OR HANDLING AMMUNITION MAY RESULT IN EXPOSURE TO LEAD AND OTHER SUBSTANCES KNOWN TO CAUSE BIRTH DEFECTS, REPRODUCTIVE HARM AND OTHER SERIOUS PHYSICAL INJURY. WASH HANDS THOROUGHLY AFTER EXPOSURE.

CAUTION: Always follow the instructions provided with your firearm cleaner and firearm lubricant.

CAUTION: The gas tube will discolor from heat. Do not attempt to remove the discoloration.

CAUTION: Some cleaners can cause damage to your firearm. You should avoid prolonged solvent immersion and prolonged ultrasonic cleaning of your firearm. Choice of solvent should be restricted to those products specifically developed for firearms maintenance. Damage to a firearm's finish may occur if these cautions are ignored. Ammoniated solvents or other strong alkaline solvents should not be used on any PKT firearm. Cleaning is essential to ensure the proper functioning of your firearm.

- Your firearm is a precision instrument. To ensure reliable function it is necessary to follow a routine maintenance procedure. After firing your firearm, be sure to unload it following the procedure outlined in the section entitled "Unloading" before performing any cleaning or maintenance procedure.
- Remove any firearm cleaning solution, oil and fingerprints from the outside surfaces of the firearm. (Finger moisture, if left, could start a corrosion process).



WARNING: NEVER MANIPULATE, ADJUST OR CHANGE ANY OF THE INTERNAL COMPONENTS OF YOUR FIREARM UNLESS SPECIFICALLY DIRECTED TO DO SO IN THIS MANUAL. IMPROPER MANIPULATION OF ANY INTERNAL COMPONENT MAY AFFECT THE SAFETY AND RELIABILITY OF YOUR FIREARM AND MAY CAUSE SERIOUS INJURY OR DEATH.



WARNING: ANY MAINTENANCE, ADJUSTMENT OR SERVICE NOT SPECIFIED IN THIS MANUAL MAY AFFECT THE SAFETY AND RELIABILITY OF YOUR FIREARM AND MUST BE PERFORMED BY A QUALIFIED GUNSMITH USING GENUINE PKT PARTS. IF YOU DO OTHERWISE, IMPROPER FUNCTIONING OF YOUR FIREARM MAY OCCUR AND SERIOUS INJURY OR DEATH MAY RESULT.

- If your firearm will be used in a cold climate, be sure to use an oil of an appropriate weight so that it will not congeal in cold temperatures, causing the interaction of important parts to be slowed or halted.

CLEANING AND MAINTENANCE CONTINUED

MAINTENANCE BEFORE STORAGE

- When storing, do not encase your firearm in anything that will attract or hold moisture, for example, leather or heavy cloth. Also, do not store firearms with a plug inserted in the barrel for this can be a contributing factor to moisture accumulation. If your firearm is to be stored for an extended period, the bore, chamber and internal surfaces should be oiled with a high quality lubricating oil or preservative intended for firearms.

- The external parts; receiver, bolt and barrel should be coated with an anti-rust oil. Before using your firearm again, be sure to clean it. Every time you clean your firearm, check it for signs of wear. If wear is noted, do not use the firearm. Return it to PKT for service or have it checked by a qualified gunsmith.

CAUTION: Use of ammunition manufactured with corrosive primers in this firearm will cause oxidation to develop on the metal parts of the firearm. To prevent such oxidation, the residue from corrosive primers must be completely removed from all metal parts after each time ammunition with corrosive primers is used in this firearm. Conventional oil or solvent-based firearm cleaners WILL NOT dissolve the residue from corrosive primers. Residue from corrosive primers MUST be completely dissolved with a water-based cleaner. After the corrosive residue has been completely dissolved from all metal parts, remove all of the water-based cleaner from the firearm and get the metal parts dry. Finally, lubricate the firearm as instructed in this manual. Failure to follow these instructions will cause serious damage to the firearm and may affect the ability of the firearm to function properly.

- Check with the ammunition manufacturer or a qualified gunsmith if you are unsure whether the particular ammunition you plan to use in this firearm has been manufactured with corrosive primers. If in doubt, follow all the instructions above to prevent oxidation caused by ammunition manufactured with corrosive primers.

- Ammunition manufactured by SAAMI member companies do not use corrosive primers.

LIMITED WARRANTY

For Owners Within The United States.

This warranty is granted by Possum Kingdom Tactical LLC. This warranty is effective from the date of purchase and applies to the *original owner* of any firearm. With respect to such firearms, this warranty supersedes any and all other warranties.

PKT firearms are warranted to be free from defects in material and workmanship. Any such defects of which PKT receives written notice, will be remedied by PKT without charge within a reasonable time after such notification and delivery of the firearm as provided below.

In the event of an emergency (repairs needed by law enforcement, an upcoming match or hunting trip), call 864-921-0472 or 864-360-5147, and ask for PKT Priority Repair Service. This allows you to speak with a PKT representative. Immediately upon receipt, your firearm will be assigned to an armorer. After the work is completed, we will return your PKT firearm.

Warranty claims (in writing) and the firearm concerned should be delivered to PKT's Customer Service Department. In addition, a copy of the bill of sale in the owner's name, or a copy of ATF Form 4473 indicating date of purchase must be included. It is important that the owner comply with all applicable federal, state and local laws and regulations in the shipment of firearms to PKT.

NOTE: See the Contact & Shipping section of this manual for further details regarding returns.

Warranty claims should state the model and serial number of the firearm concerned and the description of the difficulty experienced. It is recommended that shipments be insured by the owner, since PKT will accept no responsibility for loss or damage in transit. Transportation and insurance charges for return to owner will be paid by PKT if the claim is covered by the warranty.

UNDER NO CIRCUMSTANCES SHALL POSSUM KINGDOM TACTICAL LLC BE RESPONSIBLE FOR INCIDENTAL OR CONSEQUENTIAL DAMAGES WITH RESPECT TO ECONOMIC LOSS, INJURY, DEATH OR PROPERTY DAMAGE, WHETHER AS A RESULT OF BREACH OF THIS WARRANTY, NEGLIGENCE OR OTHERWISE.

Some states do not allow the exclusion or limitation of incidental or consequential damages, so the above limitation or exclusion may not apply to you.

LIMITED WARRANTY CONTINUED

Possum Kingdom Tactical LLC will not be responsible for:

- Defects or malfunctions resulting from careless handling, unauthorized adjustments or modifications made or attempted by anyone other than a qualified gunsmith following PKT authorized procedures, or failure to follow the disassembly instructions in the PKT manual.

- Use of defective or improper ammunition, corrosion, neglect, abuse, ordinary wear and tear, or unreasonable use.

- Criminal misuse, negligence or use under the influence of drugs or alcohol.

- PKT will repair, without charge, for the lifetime of the original owner, any PKT firearm purchased on or after July 4, 2021, that are found to have a defect in material or workmanship. Eligibility for this Lifetime Service Policy requires returning the Product Registration Card within 30 days of purchase. The Lifetime Service Policy covers functional defects; it does not include the firearm's finish, grips, magazines or sights. This warranty gives you specific legal rights. You may also have other rights that vary from state to state.

NOTE: All liability is excluded in the event that the instructions in the PKT manual are not observed.

CONTACT AND SHIPPING INFORMATION

For Owners Within The United States

NOTE: A Return Merchandise Authorization (**RMA**) is the first step in the process of returning a product in order to receive a repair, replacement or refund. Please contact PKT's Customer Service Dept. (via e-mail: support@pkt.fyi or by phone at 864-360-5147, to obtain authorization to return your firearm so we can process it quickly and efficiently. The RMA number that is supplied by PKT must be displayed on the outside of the returned product's packaging; returns without an RMA number will be routed differently which will result in delayed processing.

The issuance of an Return Merchandise Authorization (**RMA**) allows PKT an opportunity to try to diagnose and correct a customer's concerns with the product (such as ammunition problems) before it is returned. Accordingly, please contact us before returning your PKT firearm.

CONTACT CUSTOMER SERVICE

support@pkt.fyi

864-360-5147

SHIP TO SERVICE ADDRESS

PKT
132 Stoddard Road Pelzer, SC
29669

Should your PKT firearm require service, it should be returned to the PKT factory.

- Call or e-mail the Customer Service Dept. for authorization and shipping instructions.
- Ensure that the firearm is unloaded.
- **Do not attempt to ship a firearm via US Postal Service; only federally licensed dealers may ship a firearm by US Postal Service.**
- **Do not put any marking on the package indicating that the contents is a firearm.**
- **DO NOT SHIP ANY AMMUNITION.**

CONTACT AND SHIPPING CONTINUED

- Enclose a letter which includes your full name and address (no P.O. Boxes, please), daytime telephone number, email address, the serial number of the firearm, and details of the problem experienced (stating the brand and type of ammunition used when the problem occurred) or work desired.
- Record the serial number before shipping, in case you wish to check on the repair status of your firearm.
- Please remove all custom parts and accessories, such as special sights, scopes or slings from your firearm before returning.
- Place the firearm in its original case or in a similarly secure container and pack it securely.
- The package must NOT bear any markings which indicate the identity of the contents.
- It is most important that you comply with federal, state, and local laws and regulations. The following guidelines are meant to help, but you must seek assistance from the appropriate authorities if necessary.
- If your firearm must be replaced, it may be necessary to ship the replacement to a dealer rather than directly to you. You will be requested to furnish a signed FFL (Federal Firearms License) from your dealer in such an instance.
- Warranty repair work will begin upon receipt and examination of the firearm. In the case of repairs or work not covered by the warranty, a quotation covering the cost of the work plus round trip transportation charges will be sent to you. Repairs or modification will be scheduled upon receipt of payment.
- A parts list can be obtained by contacting PKT



WARNING: YOU MAY PURCHASE ACCESSORIES FOR YOUR PKT FIREARM. YOU MUST HAVE SOME OF THESE PARTS INSTALLED BY A GUNSMITH QUALIFIED TO PERFORM SERVICE ON PKT FIREARMS. YOU MUST NEVER ATTEMPT TO MODIFY YOUR FIREARM OR INSTALL REPLACEMENT PARTS IN YOUR FIREARM. ALWAYS USE A QUALIFIED PKT GUNSMITH EVEN IF THE REPAIR SEEMS TO BE SIMPLE.

CUSTOM SERVICE

We understand that PKT gun owners may want to enhance their guns with custom gunsmithing, refinishing or accessories. Our armorers offer specialized services and exclusive products to enhance your shooting experience.

Accessories for your PKT firearm are available from your local PKT Stocking Dealer, or directly from PKT.

Contact the Customer Service Department at 864-360-5147 for information about these services.

When ordering directly from the PKT, please provide the following information:

- Model
- Serial Number
- Approximate date of purchase
- Complete Return Address
- We will provide you with an invoice, payable online, before we ship your unserialized item to you.

PATENT INFORMATION

- This product may be covered by one or more patents. Visit <https://pkt.fyi> for virtual patent information.

M-LOK® ACCESSORY RAILS



WARNING: ALWAYS ENSURE THAT THE FIREARM IS UNLOADED BEFORE INSPECTING, DISASSEMBLING OR ASSEMBLING (INCLUDING ACCESSORIES) AND ALWAYS KEEP THE MUZZLE POINTED IN A SAFE DIRECTION.

The MAGPUL® M-LOK® Accessory Rail System

- The versatility of the M-LOK® system lies in accommodating various thicknesses of mounting surfaces and the adjustments that allow this functionality, the tips below will help the user to have the best possible results in the fastest possible time.

Look for the M-LOK® logo that designates genuine M-LOK® system components



FIGURE B1

PKT-LP7.5 firearm shown with M-LOK® rail in place

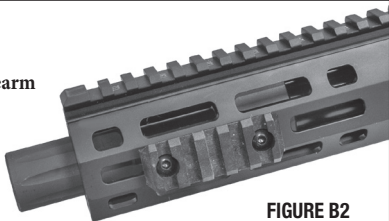

FIGURE B2

- Your M-LOK® accessory may arrive with nuts and the nylon-patched (thread lock material) screws installed or with the nuts and screws loose with the accessory you have purchased. If the screws are loose, simply thread the nuts onto the screws through the accessory rail as shown (FIGURE B3).
- The nylon patch may seem “stiff” for the first installation of the new screws into the T-Nuts. Use a 7mm wrench to hold the T-Nut and to thread it onto the screw, then backing it off to the appropriate clearance adjustment will “break in” the nylon

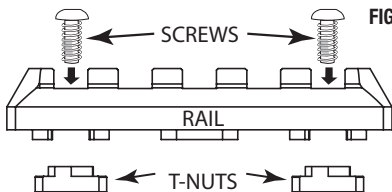

FIGURE B3

patch, and subsequent use will be easy.

M-LOK® ACCESSORY RAILS CONTINUED

- The nylon patch on the screws actually aids function by providing friction to turn the nuts. If you remove and replace the accessory numerous times, the nylon patch may eventually wear. You also may receive an after-market accessory without the patch on the screws. If the nut is not turning appropriately, the patch effect may be restored with either Rocksett™ or Loctite™ blue thread-locker stick. If the screws come without the patch, one of the above products is recommended for best function and durability.

ADJUSTING THE NUT TO THE CORRECT HEIGHT

- For best function, the T-Nut “gap” must be slightly greater than the thickness of the mounting surface (see FIGURE B4). This can be done by measuring the mounting surface thickness directly or using the edge of the mounting surface as a gauge. For most aluminum mounting surfaces setting the nuts as depicted below, with the highest edge of the T-Nut even with the bottom edge of the recoil lug, will provide correct function. Some thicker rails or polymer rails may require the nuts to be looser with a one or two thread(s) gap between the nuts and recoil lugs.

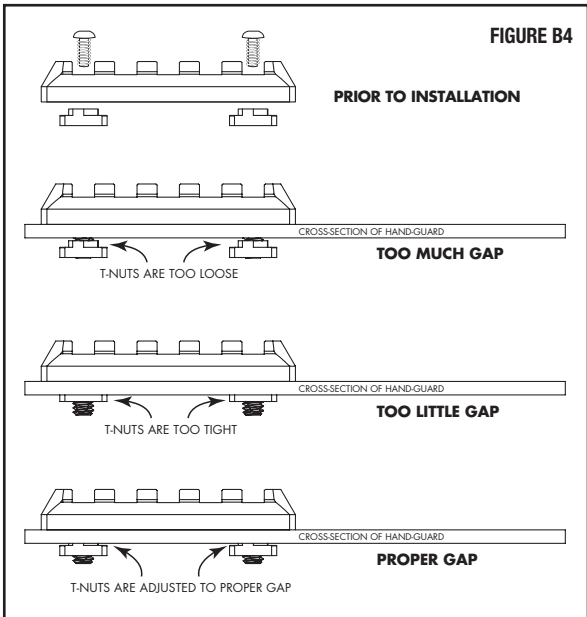

- Some accessories may arrive preset to the condition shown in the illustration for easy installation on aluminum handguards. Remember to loosen the nuts a bit for installation on polymer handguards.

M-LOK® ACCESSORY RAILS CONTINUED

- Apply some downward force on the hex wrench to make sure that the screw is seated, and then tighten (FIGURE B5).

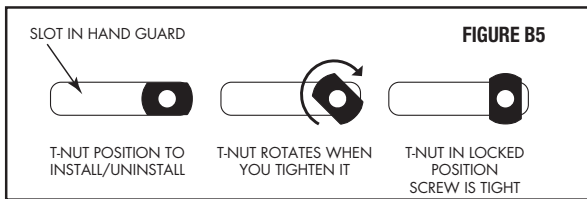

ENSURE THAT THE ACCESSORY IS FULLY SEATED INTO A SLOT AND TIGHTENED INTO POSITION WHEN MOUNTING

- The bottom of the accessory should sit flush with the mounting alignment surface. If it doesn't then slide the accessory fore-aft until it drops fully into the slot with the lugs engaged (FIGURE B6).

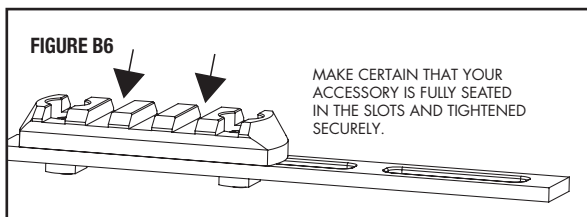

- For maximum repeatability, “bias” the accessory before fully tightening. By bias we mean settle the accessory toward the front where recoil won't give the accessory a “running start” to move when firing.
- To bias the accessory, apply just enough lateral pressure (down and forward) to the accessory to make solid contact with one side and the front (towards muzzle) of the slot, similar to when installing a Picatinny rail accessory. Then tighten all fasteners to the recommended torque spec. This step is not necessary, but aids repeatability.

WARNING: AN ACCESSORY WHICH IS NOT SECURELY MOUNTED MAY BECOME DETACHED UPON RECOIL OF THE FIREARM. IF IT BECOMES DETACHED IT MAY FLY BACK AND STRIKE THE SHOOTER OR A BYSTANDER AND CAUSE INJURY. OBSERVE THE CONDITION OF ALL THE MOUNTING SCREWS AFTER FIRING. IF THE MOUNTING SCREWS SHOW SIGNS OF LOOSENING DO NOT FIRE THE FIREARM AGAIN; TAKE IT TO A QUALIFIED GUNSMITH FOR ASSISTANCE.

M-LOK® ACCESSORY RAILS CONTINUED

ENSURE THAT THE NUT ROTATES THE FULL 90 DEGREES INTO THE LOCKED POSITION

- If you have adjusted the nuts appropriately, they should rotate into perfect 90 degree alignment with a 1/4 turn of the screw, once it is aligned, the screw draws the nut against the interior of the handguard (FIGURE B7).

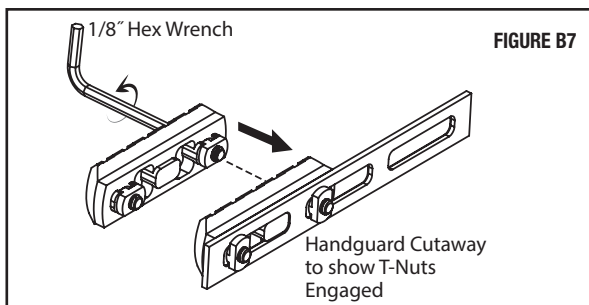

IF THE T-NUTS ARE NOT ROTATING PROPERLY:

- When nuts are spaced too loosely (where they do not contact the interior handguard surface - then the nut will rotate freely without stopping and tightening. In this case the nut will have to be screwed in closer to the bottom of the accessory. Simply remove the accessory from the slot and screw the nut on one full turn. Repeat as necessary so that the cam engages the slot when the screw is tightened.
- If the nut is spaced too close to the accessory, then the “wings” of the nut will contact the sides of the slot and the nut will not rotate into place. This will cause the nut to tighten against the accessory lugs without engaging the handguard.
- In this case the nut should be unscrewed until it is spaced far enough away from the lugs to allow it to rotate properly into position. Unscrew the nut one turn at a time and retest function.

NOTE: It is best to observe the T-Nut rotating into locked position, if possible, to be certain that it turns 90 degrees into place and stays there during tightening.

- Most handguards or other mounting surfaces have holes or vents that can be seen through to confirm that the M-LOK® T-Nuts are properly engaged with the slot, and are perpendicular to the slot orientation.

M-LOK® ACCESSORY RAILS CONTINUED

- If the nut won't rotate, or it rotates too freely to engage the handguard, you may need to hold or turn the nut with a 7mm open-end wrench (FIGURE B8).
- If it is not possible to watch the nut rotate, then careful attention needs to be paid to the screw as it is tightened. The screw should turn easily for the first quarter turn, then when the nut stops rotating it will become slightly more difficult to turn. Continue tightening until secure. Pull on both ends of the accessory to ensure it is engaged correctly.

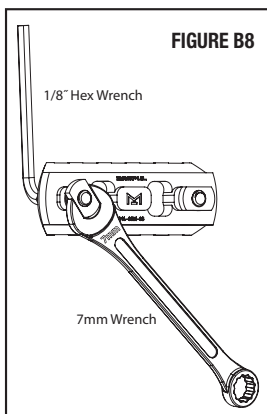

THE M-LOK® SYSTEM TORQUE SPECS

- For attaching polymer accessories to metal handguards: 15 in/lbs.
- For attaching polymer or metal accessories to polymer handguards: 15 in/lbs.
- For attaching metal accessories to metal handguards: 35 in/lbs.
- The installation torque values are not minimums, they are recommended limits. The nylon patch compound (thread lock) may slightly affect the torque reading if using an in/lb torque wrench.
- Using a small hex wrench should prevent over-tightening. Remember that the recoil lugs are doing most of the work, and excessive torque on the nuts is not required.

WARNING: APPLYING EXCESSIVE TORQUE TO THE ACCESSORY RAILS AND HANDGUARDS MAY CAUSE DAMAGE TO THEM RESULTING IN AN INSECURE MOUNT. A RAIL OR ACCESSORY WHICH IS NOT SECURELY MOUNTED MAY BECOME DETACHED UPON RECOIL OF THE FIREARM. IF IT BECOMES DETACHED IT MAY FLY BACK AND STRIKE THE SHOOTER OR A BYSTANDER AND CAUSE INJURY. OBSERVE THE CONDITION OF ALL THE RAIL COMPONENTS BEFORE FIRING. IF ANY PART OF THE MOUNT SHOWS SIGNS OF BEING LOOSE, DO NOT FIRE THE FIREARM AGAIN; TAKE IT TO A QUALIFIED GUNSMITH FOR ASSISTANCE.

REMOVAL OF ACCESSORY RAILS

- To remove, simply loosen the accessory mounting screws one full turn and the T-Nuts should loosen and align with the slot to be easily removed.

M-LOK® ACCESSORY RAILS CONTINUED

- If the T-Nuts snag when passing through the slot, simply pull up gently on the accessory and continue to loosen the screw another 1/4 to 1/2 turn, which should align the T-Nuts with the slot.
- On some polymer mounting surfaces, the T-Nuts may embed slightly into the polymer surface when tightened.
- When removing from polymer surfaces, easiest function is obtained by loosening 1/2 turn or so and then pressing down on the head of the screw with the hex wrench. This will free the T-Nut if it has been over tightened, and you may remove normally after this step.
- If you go too far in loosening before removing the accessory, the T-Nuts may have loosened past the slot to the point that they will not engage and are spinning freely. Turn screw to align, then remove accessory.

IF YOU DON'T HAVE A TORQUE WRENCH THAT MEASURES IN/LB, HERE ARE SOME TORQUE GUIDELINES: 35 in-lb using the long arm of an L-shaped hex wrench (FIGURE B9) with short end of hex wrench in the screw head.

- Standard 2 5/16" hex wrench
 - Apply 15 lb to the end of the wrench
 - Approximately 1/4" deflection at the end of the wrench.
- Long 3 13/32" hex wrench
 - Apply 9 lb. to the end of the wrench
 - Approximately 1/2" deflection at the end of the wrench. 15 in-lb using the long arm of an L-shaped hex wrench (with short end of hex wrench in the screw head).
- Standard 2 5/16" hex wrench
 - Apply 6 1/2 lb to the end of the wrench
 - Approximately 3/16" deflection at the end of the wrench.

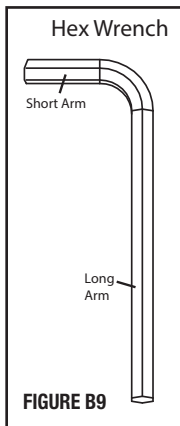

- Long 3 13/32" hex wrench
 - Apply 4 lb to the end of the wrench
 - Approximately 1/4" deflection at the end of the wrench. 15 in-lb using the short arm of an L-shaped hex wrench (with the long end of the hex wrench in the screw head).
- Apply maximum force achievable by hand.

All Rights Reserved. Magpul holds a Trademark on all of its product names and logos. The following products are trademarks of Magpul Industries Corporation, registered in the U.S. and other countries: Magpul, M-LOK.

BATTERY WARNINGS



WARNING: IF A BATTERY OPERATED ACCESSORY OR ATTACHMENT (I.E. LASER, OPTICAL SIGHT OR FLASHLIGHT, ETC.) IS SUPPLIED OR USED WITH THIS FIREARM, THE FOLLOWING WARNINGS AND INSTRUCTIONS MUST BE ADHERED TO.



WARNING: KEEP BATTERIES AWAY FROM CHILDREN. THERE IS A CHEMICAL BURN HAZARD ASSOCIATED WITH BATTERIES.



WARNING: IF A NEW OR USED LITHIUM BUTTON/COIN CELL BATTERY IS SWALLOWED OR ENTERS THE BODY, IT CAN CAUSE SEVERE INTERNAL BURNS AND CAN LEAD TO DEATH IN AS LITTLE AS 2 HOURS. ALWAYS COMPLETELY SECURE THE BATTERY COMPARTMENT. IF THE BATTERY COMPARTMENT DOES NOT CLOSE SECURELY, STOP USING THE PRODUCT, REMOVE THE BATTERIES, AND KEEP IT AWAY FROM CHILDREN. IF YOU THINK BATTERIES MIGHT HAVE BEEN SWALLOWED OR PLACED INSIDE ANY PART OF THE BODY, SEEK IMMEDIATE MEDICAL ATTENTION.

- When used correctly, batteries provide a safe and dependable source of portable power. However, misuse or abuse may result in leakage, fire, or explosion.
- Batteries can explode or leak and cause burns if installed backwards, disassembled, charged, or exposed to water, fire or high temperature.
- Always take care to install your batteries correctly observing the “+” and “-” marks on the battery and the device.
- Always replace the whole set of batteries at one time, taking care not to mix old and new batteries, or batteries of different types.
- Store unused batteries in their original packaging and away from metal objects that may short-circuit them.
- Remove discharged batteries from equipment promptly to avoid possible damage from leakage.
- Never dispose of batteries in fire. (Failure to observe this precaution may result in an explosion.)
- The batteries are supplied in a charged state and are not designed for recharging. Recharging may cause leakage, fire, or explosion.
- The batteries should be disposed of properly, including keeping them away from children.
- Dispose of used batteries immediately. Even used batteries may cause injury.

NOTES

PKT

Possum Kingdom Tactical LLC

132 Stoddard Road • Pelzer, SC 29669

<https://pkt.fyi>

864-360-5147